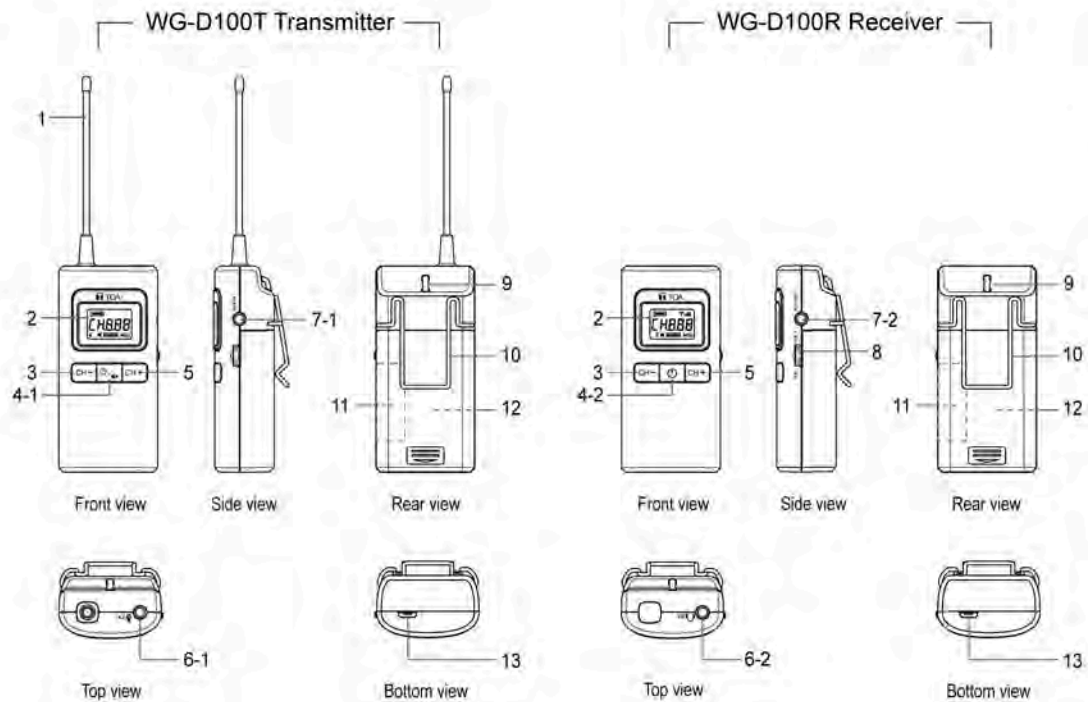

Diagram and Instructions



- 1. Antenna
- 2. LCD display
- 3. Down button for channel adjustment
- 4-1. On / Off / Mute / Set button
- 4-2. On / Off / Set button
- 5. Up button for channel adjustment
- 6-1. Microphone input
- 6-2. Earphone output
- 7-1. Aux input
- 7-2. Aux output
- 8. Earphone volume adjustment
- 9. Lanyard connection point
- 10. Belt clip
- 11. Label area
- 12. Battery compartment and One AA type battery
- 13. Micro-USB charging port



LCD Display Illustration

	WG-D100T Transmitter	WG-D100R Receiver		WG-D100T Transmitter	WG-D100R Receiver
	Channel change			—	No signal received
	Microphone Mute	—		Full battery	
	—	Earphone volume level 4		Low battery	
	—	Earphone Mute		Corresponding frequency	
	—	Good signal received		86.395 MHz	

Operating Instructions

Microphone and Earphone Connection

- WG-D100T transmitter has a built-in microphone, one external microphone-level input (3.5mm) and one auxiliary-level input (3.5mm). You can choose to use the built-in microphone or external microphone. When you connect an external microphone to the transmitter, the built-in microphone is automatically disabled. Once you unplug the external microphone, the built-in microphone will resume its use again.
- ⚠ Make sure that the microphone or the auxiliary device is connected to the correct input socket. The microphone will not operate properly if connect to the aux input socket.

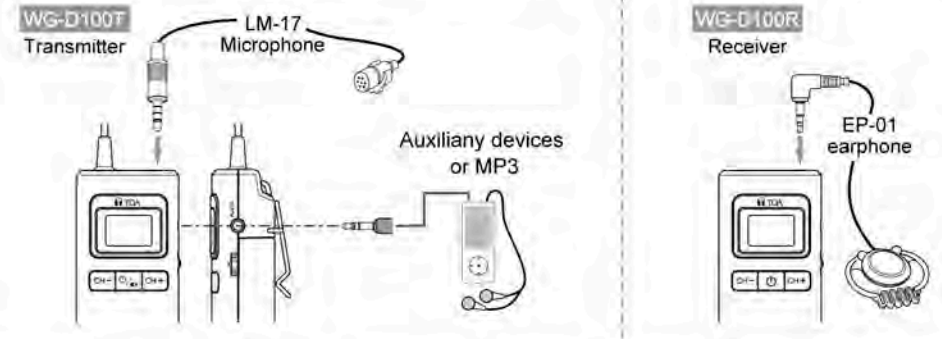

- WG-D100R Receiver has a separate earphone output (3.5mm) and an aux level output (3.5mm). Connect the earphones to the 3.5mm earphone output or connect the recorder to the aux output to capture the content. Make sure the connectors are properly inserted in place.

Power On and Off

- Press and hold the power button / for 2 seconds to turn on the system. The LCD display will illuminate and retrieve the channel number used last time to indicate Power on successfully.
- Press and hold the power button / for 2 seconds. The LCD display will disappear to indicate Power off completely.

Note :

- Energy saving- Receiver will automatically power off if no signal is received after about 20min.

How to select a channel

- The channel is preset to **CH001**. If you wish to select a different channel, press **CH-** and **CH+** buttons simultaneously for 2 seconds. The **CH-** sign starts flashing, then press **CH-** or **CH+** button to select your desired channel. Press **POWER** / **CH-** button briefly to confirm the selected channel or wait for approximately 5 seconds to automatically store the selected channel.

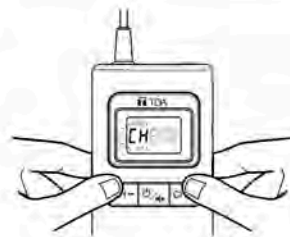

Press both buttons for 2 seconds to unlock the channel setting

Note: Make sure that the transmitter and receiver(s) operate on the same channel. This symbol will appear to indicate that the receiver is receiving a good signal from the transmitter. The receiver display will keep flashing when no transmission signal is being received. (Q & A-Q2)

Channel memory

WG-D100 can automatically memorize the channel number. It will set to the last used channel when power on next time.

Channel SYNC - Automatic channel synchronization between transmitter and receiver

Within the same group, when you change the transmitter's channel number, the receiver's channel number is wirelessly synchronized to the new channel.

- Press and hold the center of the three-way lever switch on the side of the device, the corresponding frequency will appear on the display.

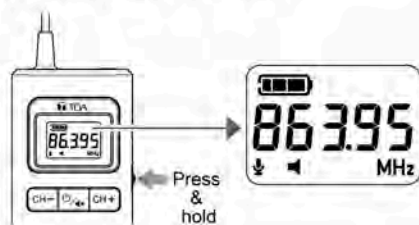

How to adjust the Volume

Transmitter:

- Press mute button briefly to mute the transmitter microphone, press the same button once again to recover.
- If the transmitter is muted for more than 20 minutes, it will turn off.

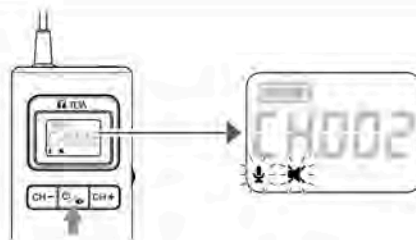

Receiver:

- Receiver earphone volume is preset at level 4.
- Press down and up the **VOL-** **VOL+** button to decrease or increase the volume level. There are 8 adjustable levels from to
- The LCD display when earphone is muted.

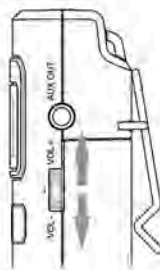

Battery Autonomy and Charging

- When battery icon is displayed at fully autonomy , the battery contains sufficient power.
- When the battery icon is displayed as empty and flashing , this indicates low battery and only 5~10% battery remaining. Please replace a new battery or charge the rechargeable battery immediately via USB certified traveling charger (optional accessories) or appropriated Linkx charger station.
- The charging current is set to 255 mA. For safety precautions, there is a safety timer that will terminate charging after 12 hours of continuous charging. Full charge battery provides approx. 14 hours of continuous operation for receiver and 12 hours of continuous operation for transmitter; however, please note that actual battery life varies based on user setting, usage patterns, environmental conditions, batteries' manufacturer and other factors.
- While charging, the battery icon displays on LCD back and forth.

Note: The transmitter or receiver will shut down automatically when charging is taking place. If you want to use the system while it's charging, simply press the power button again to turn the system back on.

How to replace the battery

Step 1 Open the battery compartment cover

Step 2 Replace with a new battery. (make sure you follow the correct polarity)

Step 3 Close the battery compartment cover

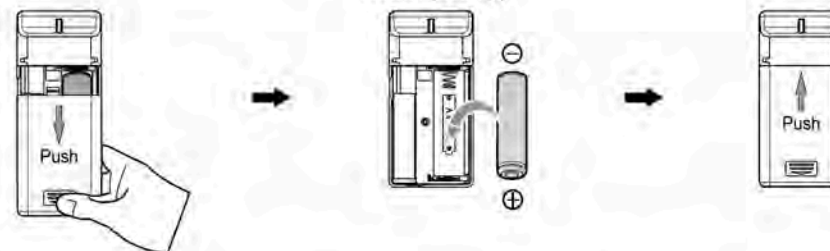

Reboot or Restart when the LCD display is Frozen or Stuck

In the unlikely event that your tour guide system becomes frozen and unresponsive, you can attempt a force shut down by removing the battery, then put the battery back again and restart your guide system.

Q & A

Q1

Sign is displayed on Transmitter

Ans

Check if the transmitter volume is muted.

Q2

The content on the LCD display of my receiver is flashing

Ans

This indicates that no transmission signal is being received. Make sure your transmitter is powered on, and the receiver is within the normal receiving range. Both transmitter and receiver are operated on the same channel and same frequency.

To ensure proper signal being received, set transmitter and receiver at least 30 cm apart. System being placed too close will cause the transmitted signal arrived at the receiver saturated instantly, system will then collapse and receiver will muted.